

8PAR53

Soluzione aperta / Open solution H 2030 mm

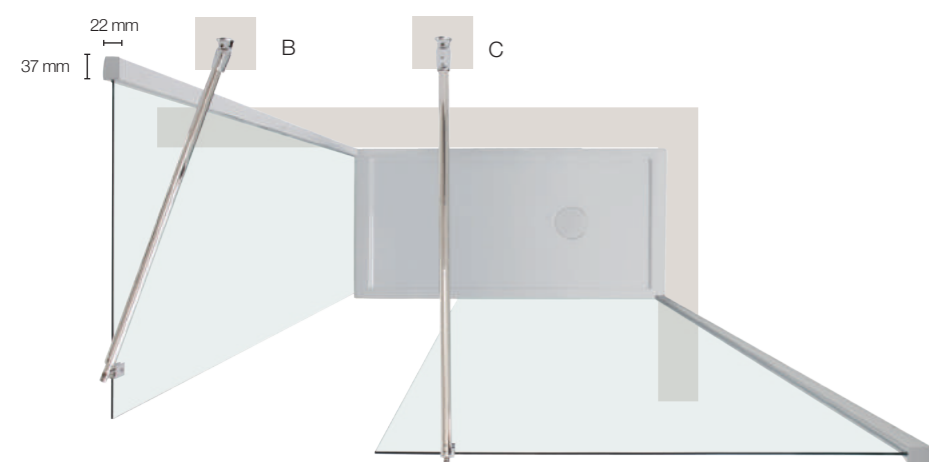

Versione 8PAR53 da 1100 mm + lato 8PAR53 da 700 mm
8PAR53 Version mm 1100 + side 8PAR53 mm 700

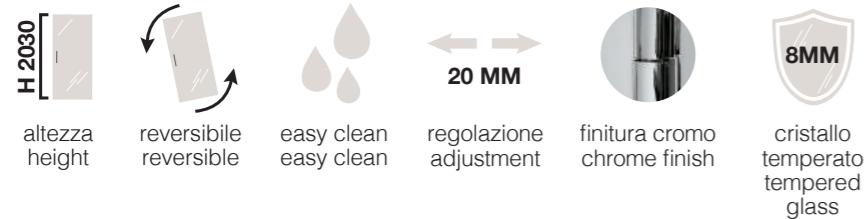
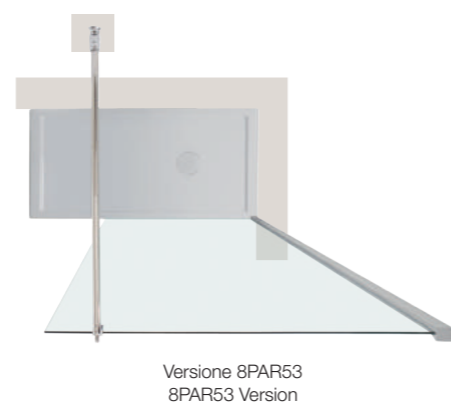

(B) L'estensibilità dell'asta di fissaggio varia da 500 mm fino a 800 mm
(B) The extension of the support arm can vary from 500 mm to 800 mm

(C) L'estensibilità dell'asta di fissaggio varia da 710 mm fino a 1200 mm
(C) The extension of the support arm can vary from 710 mm to 1200 mm

SINGOLO LATO
SINGLE SIDE PANEL

Specifiche tecniche / Technical specifications					
Dimensioni (A) / Sizes (A)					
L/W	H/H	Peso vetro kg	Estensibilità mm	Estensibilità asta di fissaggio di serie mm (B)	Estensibilità asta di fissaggio di serie mm (C)
mm	mm	Glass weight kgs	Extension mm	Extension of the standard support arm mm (B)	Extension of the standard support arm mm (C)
700	2030	39	680-700	500-800	-
800	2030	44	780-800	500-800	-
900	2030	49	880-900	500-800	-
1000	2030	53	980-1000	-	710-1200
1100	2030	58	1080-1100	-	710-1200
1200	2030	63	1180-1200	-	710-1200
1300	2030	68	1280-1300	-	710-1200
1400	2030	73	1380-1400	-	710-1200

8PAR54

Soluzione aperta / Open solution H 2030 mm

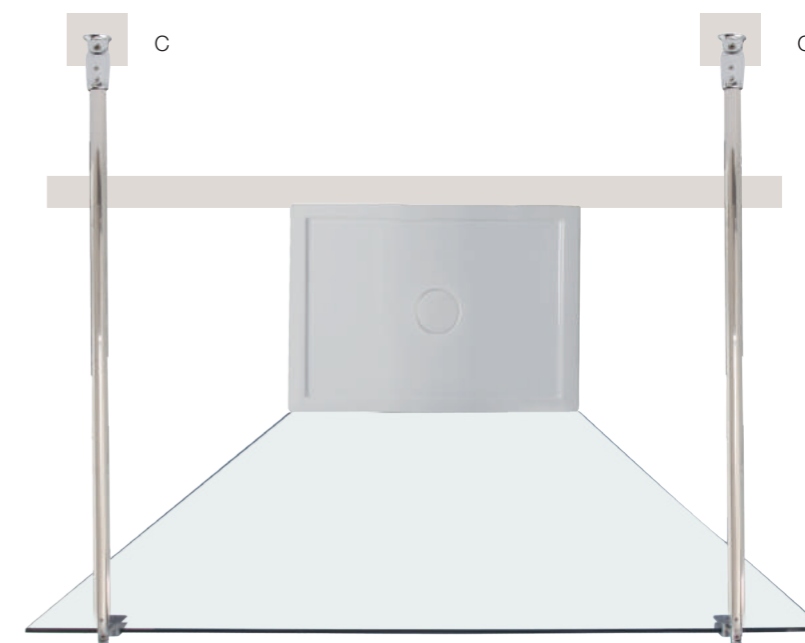
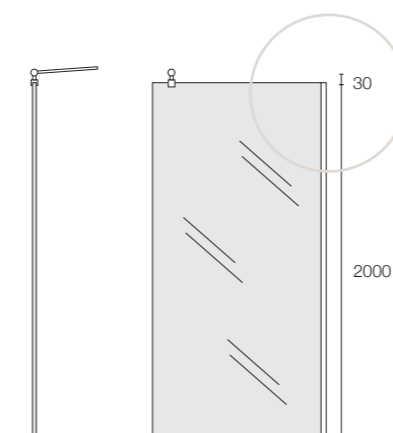
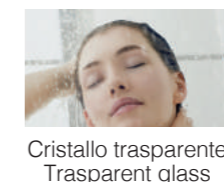
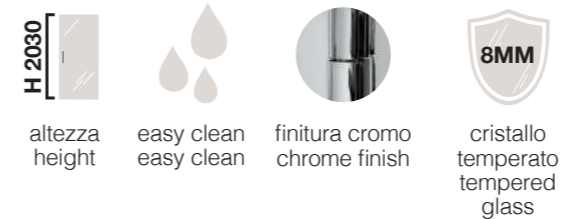
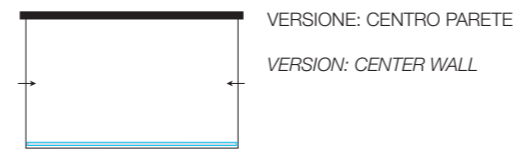

(C) L'estensibilità dell'asta di fissaggio varia da 710 mm fino a 1200 mm
(C) The extension of the support arm can vary from 710 mm to 1200 mm

BOX COMPLETO
COMPLETE SHOWER ENCLOSURE

Specifiche tecniche / Technical specifications			
L/W	H/H	Peso vetro kg	Estensibilità asta di fissaggio di serie mm (C)
		Glass weight kgs	Extension of the standard support arm mm (C)
1000	2030	53	710-1200
1100	2030	58	710-1200
1200	2030	63	710-1200
1300	2030	68	710-1200
1400	2030	73	710-1200
1500	2030	78	710-1200
1600	2030	83	710-1200